

Product Name: LED T8 Tube Series

Product Model: LEDEM14.5T8/FR20/8CCT3/MV

Product includes the following components:

| PARTS       | QUANTITY (Carton Pack) |
|-------------|------------------------|
| Lamp        | 10 pcs/box             |
| AC Wire     | 10 pcs/box             |
| Test Switch | 10 pcs/box             |
| Fixed Clip  | 10 pcs/box             |
| Adapter     | 10 pcs/box             |

## 1. Product Features:

- UL certified
- Full glass housing: No Aging, Yellowing, Bending.

## 2. Product Applications:

Widely used in residential buildings, offices, shopping malls, supermarkets, hospitals, assembly lines, warehouses, etc. for energy saving illumination.

## 3.PARTS/COMPONENTS INCLUDED IN KIT

- Installation Instructions
- Emergency LED tube x 1 PCS
- Luminaire Marking Labels
- Miscellaneous Hardware

## 4. Installation Instructions:

Please completely comply with these instructions and notes, to ensure that the product is operated in a safe condition.

### ⚠ Safety Precautions :

For your and others' safety, please read the precaution carefully before installation:

- (1). Product should be installed by qualified electrician.
- (2). Switch off the power supply before commencing work, make sure correct connection before power on.



### WARNING/ADVERTENCIA/AVERTISSEMENT

To reduce the risk of electrical shock, fire, or injury to persons; read and follow all warnings and installation instructions before installing. All installation should be performed by a qualified electrician.

#### Risk of Electric Shock

Ensure power is off before installation or inspection. All wirings are performed in accordance with Electrical Code and local electrical code.

#### Risk of Fire

Fixtures are rated for use with electronic ballast and 90°C rated supply wire.

Para reducir el riesgo de descarga eléctrica, incendio o lesiones a personas, lea y siga todas las advertencias e instrucciones de instalación antes de realizarla. Toda instalación debe ser efectuada por un electricista cualificado.

#### Riesgo de descarga eléctrica

Asegúrese de desconectar la corriente antes de la instalación o inspección. Todos los cableados se realizan de acuerdo con el Código Eléctrico y el código eléctrico local.

#### Riesgo de incendio

Los accesorios están clasificados para uso con balasto electrónico y cable de alimentación clasificado para 90°C.

Lisez et suivez les instructions d'installation et les avertissements avant l'installation. Toute l'installation doit être exécutée par un électricien qualifié, pour réduire les risques de choc électrique, de feu ou de blessures corporelles.

#### Risque de choc électrique

Assurez-vous que le courant soit coupé avant l'installation ou l'inspection et que tout le câblage soit effectué en conformité avec le code d'électricité et le code local d'électricité.

#### Risque de feu

Les luminaires sont conçus pour être utilisés avec un ballast électronique et un fil d'alimentation de 90°C.

### FOR YOUR SAFETY

While performing installations described, gloves, safety glasses or goggles should be worn.

### PARA SU SEGURIDAD

Mientras realice las instalaciones descritas, se recomienda el uso de guantes y gafas de seguridad.

### POUR VOTRE SÉCURITÉ

Vous devriez porter des gants et des verres de protection lors des installations détaillées.

## INSIDE THE BOX

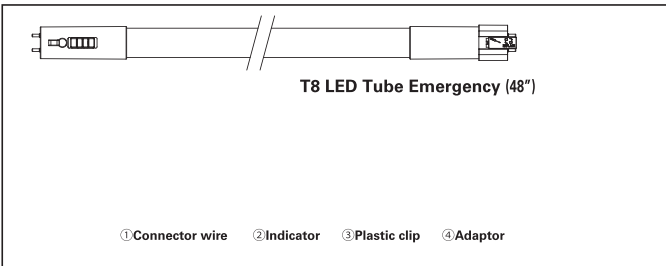

Plusrite USA  
2000 S. Grove Ave, Bldg B  
Ontario CA 91761

T:909-930-6868  
T:888-758-7443  
F:909-930-9988

www.naturaled.com

# INSTALLATION INSTRUCTIONS

1. Turn the DIP switch at the B side to the "ON" position;

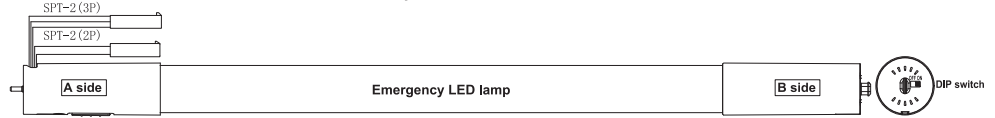

2. Combine the adapter and the end cap at B side;

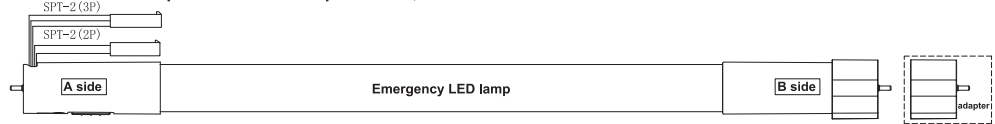

3. Disconnect power to the fixture;

4. Remove existing tubes, reflector, and remove the lamp housing;

5. Open a round hole at a suitable position on the lamp fixture, the hole is 200-300mm away from the lamps A-end, and the hole diameter is 13-14mm;

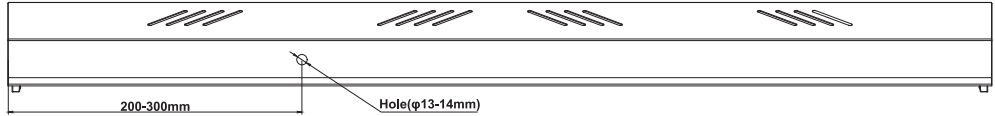

6. Insert the connector end of the external inspection line into the interior of the lamp fixture along the small hole, and install the button in the opened small hole;

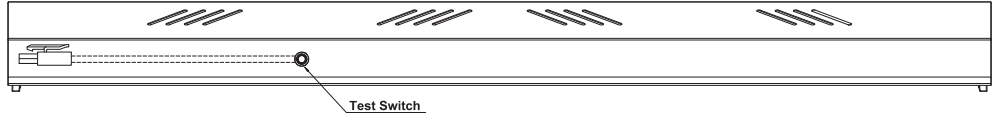

7. Connect the AC terminal wire (Black, White, Red) in the Accessory box to the Junction Box;

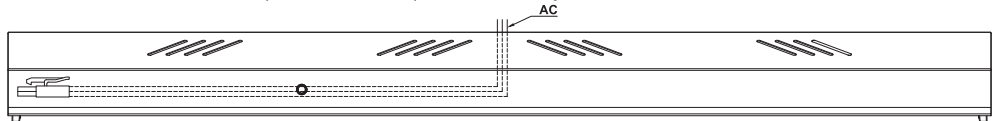

8. Install the lamp housing, reflector, and existing tubes;

9. Install the Emergency LED lamp;

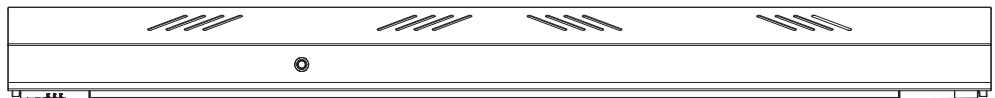

10. AC & Test Switch terminal male and female are plugged together;

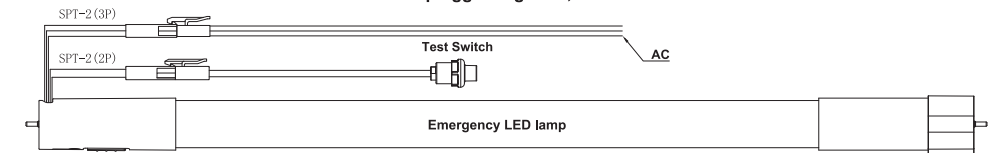

11. The AC wire and the Test Switch wire enter the interior of the fixture;

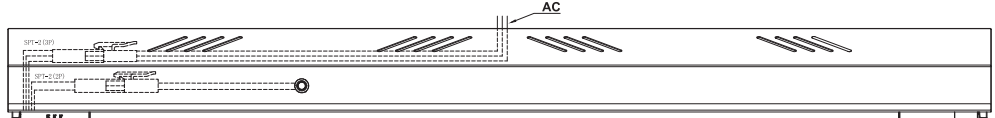

12. Install the Fixed Clip at the B side.

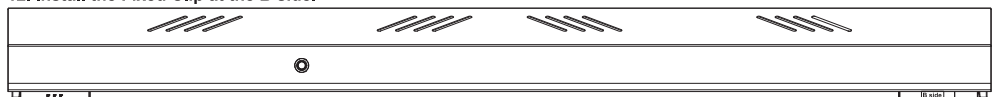

# Wiring Instruction

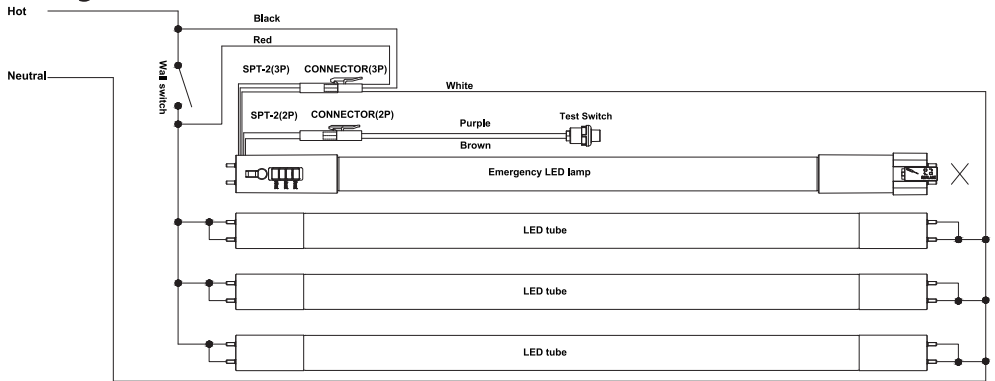

**WARNING - Risk of fire or electric shock. LED Retrofit Kit installation requires knowledge of luminaires electrical systems. If not qualified, do not attempt installation. Contact a qualified electrician.**

**AVERTISSEMENT - Risque d'incendie ou de choc électrique. Installation du kit de Retrofit LED exige une connaissance des systèmes électriques luminaires. Si vous n'êtes pas qualifié, ne tentez pas de l'installation. Contactez un électricien qualifié.**

**WARNING - Risk of fire or electric shock. Install this kit only in the luminaires that have the construction features and dimensions shown in the photographs and/or drawings and where the input rating of the retrofit kit does not exceed the input rating of the luminaire.**

**AVERTISSEMENT - Risque d'incendie ou de choc électrique. Installez ce kit dans les luminaires qui ont les caractéristiques de construction et les dimensions indiquées dans les photographies et / ou dessins et où la cote d'entrée du kit de modification ne dépasse pas la capacité d'entrée du luminaire.**

**Only those open holes indicated in the photographs and/or drawings may be made or altered as a result of kit installation. Do not leave any other open holes in an enclosure of wiring or electrical components.**

**WARNING - To prevent wiring damage or abrasion, do not expose wiring to edges of sheet metal or other sharp objects.**

**AVERTISSEMENT - Pour éviter d'endommager le câblage ou à l'abrasion, ne pas exposer le câblage aux bords de tôle ou d'autres objets pointus.**

**Installers should not disconnect existing wires from lampholder terminals to make new connections at lampholder terminals. Instead installers should cut existing lampholder leads away from the lampholder and make new electrical connections to lampholder lead wires by employing applicable connectors.**

**FOR RETROFIT KITS CERTIFIED TO CANADIAN REQUIREMENTS THE RETROFIT KIT IS ACCEPTED AS A COMPONENT OF A LUMINAIRE WHERE THE SUITABILITY OF THE COMBINATION SHALL BE DETERMINED BY AUTHORITIES HAVING JURISDICTION. PRODUCT MUST BE INSTALLED BY A QUALIFIED ELECTRICIAN IN ACCORDANCE WITH THE APPLICABLE AND APPROPRIATE ELECTRICAL CODES. THE INSTALLATION GUIDE DOES NOT SUPERSEDE LOCAL OR NATIONAL REGULATIONS FOR ELECTRICAL INSTALLATIONS.**

**Installers should examine all parts that are not intended to be replaced by the retrofit kit for damage and replace any damaged parts prior to installation of the retrofit kit.**

**WARNING - Risk of fire or electric shock. Luminaire wiring and electrical parts may be damaged when drilling for installation of LED retrofit kit. Check for enclosed wiring and components.**

**The retrofit position is located at the edge of the Target Luminaire which installed Max four LED Tubes.**

The kit are intended to retrofit Target luminaires with the following characteristics:

1. Surface mounted, Type IC or Type non-IC recessed mounted.
2. With or without diffuser.
3. Not dimmable.
4. Max 4 LED Tubes, Model #: LEDEM14.5T8/FR20/8CCT3/MV
5. The retrofit position is located at the edge of the four LED Tubes.
6. One single branch circuit as power supply connection.
7. Refer to below table for Min compartment dimension.
8. Max. mounting height: 8.07 ft

|                  | Original LED Tube         | MINIMUM LAMP COMPARTMENT DIMENSIONS<br>[length x Width x Height] [mm] | Max No. | Minimum Spacing between tube lamps,<br>center to center(cm) | Dimmable? |
|------------------|---------------------------|---|---------|---|-----------|
| Target Luminaire | LEDEM14.5T8/FR20/8CCT3/MV | 1215x605x75   | 4       | 12  | NO        |

This device complies with Part 15 of the FCC Rules. Operation is subject to the following two conditions: (1) this device may not cause harmful interference, and (2) this device must accept any interference received, including interference that may cause undesired operation.